



## EDX Markets™ FIX Specifications – Order Entry

EDX Markets

v1.0.15

These specifications are being provided to you strictly for informational purposes solely for the purpose of developing or operating systems for your use that interact with systems of EDX Markets LLC ("EDX Markets™"). These specifications are proprietary to EDX Markets™ and constitute the intellectual property of EDX Markets™. All title and intellectual property rights in and to the specifications is owned exclusively by EDX Markets™ and its parent and affiliates; other than as expressly set forth herein, no license or other rights in or to the specifications and intellectual property rights related thereto are granted to you. EDX Markets™ reserves the right to withdraw, modify, or replace the specifications at any time, without notice. No agreement is provided by EDX Markets™ regarding the level, scope, or timing of EDX Markets™ implementation of the functions or features discussed in these specifications. THESE SPECIFICATIONS ARE PROVIDED TO YOU "AS IS", "WITH ALL FAULTS" AND EDX DISCLAIMS ANY AND ALL WARRANTIES, EXPRESS, IMPLIED, STATUTORY OR OTHERWISE TO THE SPECIFICATIONS. EDX MARKETS™ WILL NOT BE LIABLE FOR ANY INCOMPLETENESS OR INACCURACIES. EDX MARKETS™ WILL NOT BE LIABLE FOR ANY INDIRECT, SPECIAL, INCIDENTAL, PUNITIVE, OR CONSEQUENTIAL DAMAGES HOWEVER CAUSED, WHETHER IN CONTRACT, TORT OR UNDER ANY OTHER THEORY OF LIABILITY, RELATING TO THE SPECIFICATIONS OR THEIR USE, EVEN IF IT HAS BEEN ADVISED OF THE POSSIBILITY OF SUCH DAMAGE. It is further agreed by you that, by using these specifications, you agree not to copy, reproduce, or permit access to the information contained in the specifications except to those with a need-to-know for the purposes stated above. It is emphasized that these specifications are provided to you in reliance upon your acknowledgement and acceptance that this material is being solely made to and direct at you for the purposes of lawfully using these specifications.

# EDX Markets™ FIX Specifications – Order Entry

v1.0.15

## Table of Contents

<b>CHANGE LOG</b> .....	<b>3</b>
<b>OVERVIEW</b> .....	<b>7</b>
THROTTLE LIMITS .....	7
SEQUENCE RESET .....	7
CANCEL ON DISCONNECT .....	7
UNSOLICITED CANCEL .....	7
TEST REQUEST .....	8
RESEND REQUEST .....	8
SUPPORTED MESSAGES .....	8
<b>SESSION MESSAGES</b> .....	<b>8</b>
STANDARD HEADER (IN) .....	8
STANDARD HEADER (OUT) .....	9
STANDARD FOOTER .....	9
LOGON INTERACTION MODEL: .....	10
LOGON (IN) .....	10
LOGON (OUT) .....	11
SAMPLE MESSAGES: .....	11
<i>Logon (IN)</i> .....	11
<i>Logon (OUT)</i> .....	12
LOGOUT (IN) .....	12
LOGOUT (OUT) .....	12
SAMPLE MESSAGES: .....	12
<i>Logout (IN)</i> .....	12
<i>Logout (OUT)</i> .....	13
TESTREQUEST INTERACTION MODEL: .....	13
TESTREQUEST (OUT) .....	13
SAMPLE MESSAGES: .....	14
<i>TestRequest (OUT)</i> .....	14
<i>Heartbeat (IN)</i> .....	14
RESENDREQUEST INTERACTION MODEL: .....	14
RESENDREQUEST (OUT) .....	14
SEQUENCERESET (IN) .....	15
REJECT (OUT) .....	15
SAMPLE MESSAGES: .....	15
<i>ResendRequest (OUT)</i> .....	15
<i>SequenceReset (IN)</i> .....	16
<i>Reject (OUT)</i> .....	16
<b>APPLICATION MESSAGES</b> .....	<b>17</b>
NEWORDERSINGLE INTERACTION MODEL: .....	17
NEWORDERSINGLE (IN) .....	17
EXECUTIONREPORT (OUT) .....	18
BUSINESSMESSAGEREJECT (OUT) .....	22
REJECT (OUT) .....	22

SAMPLE MESSAGES: .....	22
<i>NewSingleOrder (IN)</i> .....	22
<i>ExecutionReport NEW (OUT)</i> .....	23
<i>ExecutionReport TRADE (OUT)</i> .....	24
<i>ExecutionReport EXPIRED (OUT)</i> .....	24
<i>ExecutionReport REJECTED (OUT)</i> .....	25
<i>BusinessMessageReject (OUT)</i> .....	26
<i>Reject (OUT)</i> .....	26
ORDERCANCELREQUEST INTERACTION MODEL: .....	27
ORDERCANCELREQUEST (IN) .....	27
ORDERCANCELREPLACEREQUEST (IN) .....	27
EXECUTIONREPORT (OUT) .....	28
ORDERCANCELREJECT (OUT) .....	30
BUSINESSMESSAGEREJECT (OUT) .....	31
SAMPLE MESSAGES: .....	31
<i>OrderCancelRequest (IN)</i> .....	31
<i>OrderCancelReplaceRequest (IN)</i> .....	32
<i>ExecutionReport CANCELLED (OUT)</i> .....	32
<i>ExecutionReport REPLACE (OUT)</i> .....	33
<i>ExecutionReport ADMINISTRATIVE CANCEL (OUT)</i> .....	34
<i>OrderCancelReject (OUT)</i> .....	34
<i>BusinessMessageReject (OUT)</i> .....	35
ORDERMASSSTATUSREQUEST INTERACTION MODEL: .....	35
ORDERMASSSTATUSREQUEST (IN) .....	36
EXECUTIONREPORT (OUT) .....	36
ORDERMASSSTATUSREQUESTEND (OUT) .....	38
SAMPLE MESSAGES: .....	38
<i>OrderMassStatusRequest (IN)</i> .....	38
<i>ExecutionReport (OUT)</i> .....	38
<i>OrderMassStatusRequestEnd (OUT)</i> .....	39
ORDERMASSCANCELREQUEST INTERACTION MODEL: .....	39
ORDERMASSCANCELREQUEST (IN) .....	40
ORDERMASSCANCELREPORT (OUT) .....	40
EXECUTIONREPORT (OUT) .....	41
SAMPLE MESSAGES: .....	42
<i>OrderMassCancelRequest (IN)</i> .....	42
<i>OrderMassCancelReport (OUT)</i> .....	43
<i>ExecutionReport (OUT)</i> .....	43

## Change Log

Date	Section / Message(s)	Description
3/4/2024	N/A	Initial v1.0 release of FIX Order Entry specifications for EDX Markets match engine.
3/14/2024	Logon Message	v1.0.1 - Updated sample Logon message to include standard header/footer.
3/26/2024	Tag 18 - ExecInst	v1.0.2 - Removed option for cancel on system failure.
3/26/2024	Tag 851 - LastLiquidityInd	v1.0.2 - Enumerated options for liquidity codes.
4/24/2024	ExecutionReport, OrderCancelReject	v1.0.3 - Enumerated options for CxlRejReason and OrdRejReason codes
4/25/2024	OrderMassCancelRequest (IN)	v1.0.4 - Updated OrderMassCancelRequest (IN) to correct MsgType 35='q'
4/26/2024	Login (IN)	v1.0.5 - Updated ResetSeqNumFlag
4/26/2024	Logout (OUT)	v1.0.5 - Updated ResetSeqNumFlag
4/26/2024	OrderMassCancelRequest (IN)	v1.0.5 - Updated required = 'Y'
4/26/2024	Login (IN)	v1.0.5 - Updated ResetSeqNumFlag values/comments
4/26/2024	Logout (OUT)	v1.0.5 - Updated ResetSeqNumFlag values/comments
4/29/2024	Interaction Model	v1.0.6 - Added interaction model
5/1/2024	Throttle Limits	v1.0.7 - Added Throttle Limits
5/3/2024	OrderMassStatusRequest (OUT), ExecutionReport (OUT), OrderCancelReject (OUT)	v1.0.8 - Added references to values 8 [REJECTED] and C [EXPIRED] for Tag 39 (OrdStatus)
5/3/2024	OrderMassStatusRequest (OUT)	v1.0.8 - Removed reference to D [RESTATED] and added I [ORDER STATUS] for Tag 150 (ExecType)
5/7/2024	OrderMassStatusRequest (OUT), ExecutionReport (OUT)	v1.0.9 - Removed reference to 5 [REPLACED] for Tag 150 (ExecType)
5/7/2024	ExecutionReport (OUT)	v1.0.9 - Removed reference to D [RESTATED] for Tag 150 (ExecType)
5/9/2024	OrderMassCancelRequest (IN), OrderMassCancelReport (OUT)	v1.0.10 - Corrected example for mass cancel requests and reports from occurring at account level to occurring at the session level
5/13/2024	Sequence Reset	v1.0.11 - Added Sequence Reset section
5/13/2024	Cancel on Disconnect	v1.0.11 - Added COD section
5/14/2024	OrderMassStatusRequest (OUT) ExecutionReport (OUT)	v1.0.12 - AvgPx changed to "Always 0"
6/7/2024	Sequence Reset	v1.0.13 - Added interaction model
7/30/2024	Overview	v1.0.14

		<ul style="list-style-type: none"> <li>- Interaction model broken down into several models for each corresponding message.</li> <li>- Unsolicited Cancel section added.</li> <li>- Test Request section added.</li> <li>- Resend Request section added.</li> <li>- Separated Standard Header into (IN) and (OUT) messages.</li> </ul>
7/30/2024	Logon	v1.0.14 <ul style="list-style-type: none"> <li>- Logon Interaction model created.</li> <li>- Tag 1408 (DefaultCstmAppVerID) no longer in Logon (IN).</li> <li>- Logout (IN) matrix added.</li> <li>- Logout (IN) and Logout (OUT) sample messages added.</li> </ul>
7/30/2024	Test Request	v1.0.14 <ul style="list-style-type: none"> <li>- Test Request interaction model added.</li> <li>- Test Request (OUT) matrix added.</li> <li>- Test Request (OUT) sample message added.</li> <li>- Heartbeat in sample message added.</li> </ul>
7/30/2024	Resend Request	v1.0.14 <ul style="list-style-type: none"> <li>- Resend Request interaction model added.</li> <li>- Resend Request (OUT) matrix added.</li> <li>- Sequence Reset (IN) matrix added.</li> <li>- Reject (OUT) matrix added.</li> <li>- Resend Request (OUT) sample message added.</li> <li>- Sequence Reset (IN) sample message added.</li> <li>- Reject (OUT) sample message added.</li> </ul>
7/30/2024	New Single Order	v1.0.14 <ul style="list-style-type: none"> <li>- New Single Order interaction model added.</li> <li>- Values/comments under tag 59 updated (6 and A show same value).</li> <li>- Execution Report (OUT) matrix added below New Single Order.</li> <li>- Execution Report NEW, TRADE, EXPIRED, REJECTED (OUT) sample messages added below new single order.</li> <li>- Reject (OUT) Matrix added</li> <li>- Business Message Reject (OUT) matrix added</li> <li>- Reject sample message added.</li> <li>- Business Message Reject sample message added.</li> </ul>
7/30/2024	Order Cancel Request	v1.0.14

		<ul style="list-style-type: none"> <li>- Order Cancel Request interaction model added.</li> </ul>
7/30/2024	Order Cancel Replace Request	<p>v1.0.14</p> <ul style="list-style-type: none"> <li>- Included in Order Cancel Request interaction model.</li> <li>- Tag 44 (Price) changed req'd to yes.</li> <li>- Tag 59 (TIF) changed req'd to yes.</li> <li>- Tag 126 (ExpireTime) added missing req'd as N.</li> <li>- Execution Report (OUT) matrix added.</li> <li>- Order Cancel Reject (OUT) matrix added.</li> <li>- Order Cancel Request (IN) sample message added</li> <li>- Order Cancel Replace Request (IN) sample message updated.</li> <li>- Execution Report CANCELLED, REPLACE, ADMINISTRATIVE CANCEL, ORDER CANCEL REJECT (OUT) sample messages added.</li> <li>- Added Business Message Reject (OUT) matrix</li> <li>- Added Business Message Reject (OUT) sample message</li> </ul>
7/30/2024	Order Mass Status Request	<p>v1.0.14</p> <ul style="list-style-type: none"> <li>- Order Mass Status Request interaction model added</li> <li>- Execution Report (OUT) matrix added.</li> <li>- Order Mass Status Request End (OUT) matrix added.</li> <li>- Order Mass Status Request (IN) sample message updated.</li> <li>- Order Mass status request (OUT) matrix completely removed as we do not return that message.</li> <li>- Order mass status request (IN) sample message added.</li> <li>- Execution report (OUT) sample message added.</li> <li>- Order Mass status request end (OUT) sample message added.</li> </ul>
7/30/2024	Order Mass Cancel Request	<p>v1.0.14</p> <ul style="list-style-type: none"> <li>- Order Mass Cancel Request interaction model added.</li> <li>- Tag 55 (Symbol) req'd changed to Y.</li> <li>- Footnote added to tag 55 (Symbol).</li> </ul>

		<ul style="list-style-type: none"> <li>- Order Mass Cancel Report (OUT) matrix added.</li> <li>- Execution Report (OUT) matrix added.</li> <li>- Order Mass Cancel Request (IN) sample message updated.</li> <li>- Order Mass Cancel Report (OUT) sample message added.</li> <li>- Execution Report (OUT) sample message added.</li> </ul>
7/30/2024	Execution Report	<p>v1.0.14</p> <ul style="list-style-type: none"> <li>- The appropriate execution report matrix and sample message was added to each corresponding message that returns a 35=8 message.</li> <li>- Within each one of these execution reports is its own unique matrix appropriate for the response.</li> </ul>
08/29/2024	Execution Report	<p>V1.0.15</p> <ul style="list-style-type: none"> <li>- NoMiscFees added</li> <li>- MiscFeeAmt added</li> <li>- MiscFeeCurr added</li> <li>- MiscFeeType added</li> </ul>

## Overview

EDX Markets FIX specifications are based on the FIX Trading Community FIX 5.0 SP2 specifications.

## Throttle Limits

The following throttle limits are applied at the FIX ID level and are administered by EDX market operations.

- Maximum messages per account: 1000 messages per 5 seconds.
- In the event the user exceeds the throttle limits listed above, the user will be disconnected from the session and receive the message RATE\_LIMIT\_EXCEEDED as the reason for disconnecting.

## Sequence Reset

- A daily reset occurs at 12pm ET. We follow the FIX protocol convention for resetting sequence numbers back to 1.

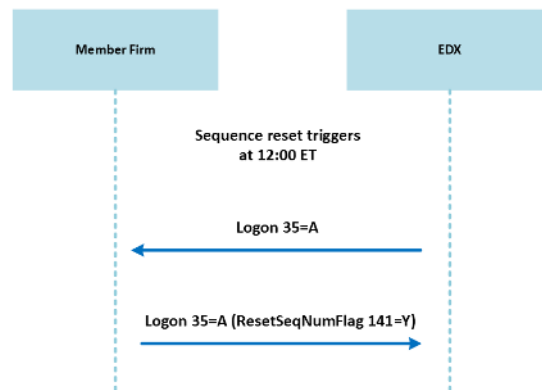

## Cancel On Disconnect

- Cancel on Disconnect is configured by default for all FIX Order Entry session IDs. Upon a disconnect all GTD/GTT orders will be cancelled, but GTC orders will remain on the book.

## Unsolicited Cancel

- In the event EDX cancels an order, you will receive an 'ExecutionReport' message from EDX to the member firm confirming details of the cancel. These messages can be identified by tag 39=4, 150=4 and, 58=ADMINISTRATIVE\_CANCEL.



## Test Request

- If your system fails to heartbeat with us in the interval initially declared in the logon message, EDX will issue a Test Request. When that happens, you must respond to the Test Request within the initially declared heartbeat interval with either a business message or a heartbeat.

## Resend Request

- If EDX detects a gap in the Message Sequence Number, there will be a Resend Request issued. When that happens, you can respond with the missing block of messages or perform a gap fill. This can be accomplished by sending a Sequence Reset Message (Tag 35=4), with the New Sequence Number (Tag 36) and whether you would like the gap in messaging filled (Tag 123 = Y/N). When a gap fill is requested, EDX will only send 'application' level messages. We also will not send any messages that would've been sent while the client was disconnected. We only store those historical messages when the engine thinks the client is connected.

## Supported Messages

The following convention is used in this document to indicate message direction:

- IN: a message type received by EDX.
- OUT: a message type originating from EDX.
- IN/OUT: a message type that can be sent to or from EDX.

The values under the “Required” column indicate one of the following:

- ‘Y’ – field is mandatory and must be sent or received as a part of the message.
- ‘N’ – field is not required and should be omitted unless otherwise directed by EDX.
- ‘N/A’ – Field is not used in the context of the message.

## Session Messages

### Standard Header (IN)

Tag	Field Name	Req'd	Values/Comments
8	BeginString	Y	'FIXT.1.1'. Message start. Must be the first field in the message.
9	BodyLength	Y	Length of the FIX message. Must be the second field in the message.
35	MsgType	Y	Type of FIX message. Must be the third field in the message.
34	MsgSeqNum	Y	Message sequence number.
52	SendingTime	Y	UTC timestamp. Time of message.
49	SenderCompID	Y	Message sender's ID. Assigned at onboarding (same as Username).
56	TargetCompID	Y	'EDXM'

43	PossDupFlag	N	Required for retransmitted messages, whether prompted by the sending system or as the result of a resend request.
97	PossResend	N	Required when message may be duplicate of another message sent under a different sequence number.
122	OrigSendingTime	N	Required for message resent because of a resend request. If data is unavailable, set to same value as SendingTime.

### Standard Header (OUT)

Tag	Field Name	Req'd	Values/Comments
8	BeginString	Y	'FIXT.1.1'. Message start. Must be the first field in the message.
9	BodyLength	Y	Length of the FIX message. Must be the second field in the message.
35	MsgType	Y	Type of FIX message. Must be the third field in the message.
49	SenderCompID	Y	'EDXM'
56	TargetCompID	Y	Message sender's ID. Assigned at onboarding (same as Username).
34	MsgSeqNum	Y	Message sequence number.
52	SendingTime	Y	UTC timestamp. Time of message.
43	PossDupFlag	N	Required for retransmitted messages, whether prompted by the sending system or by a resend request.
97	PossResend	N	Required when message may be duplicate of another message sent under a different sequence number.
122	OrigSendingTime	N	Required for message resent because of a resend request. If data is unavailable, set to same value as SendingTime.

### Standard Footer

Tag	Field Name	Req'd	Values/Comments
10	Checksum	Y	A value calculated by the FIX engine from the message data and transferred with the data. If the data received does not match the CheckSum value, the data was corrupted in transit.

### Logon Interaction Model:

- Upon a Logon (IN) request, a Logon (OUT) request is sent, but no other application messages are sent without a corresponding request.

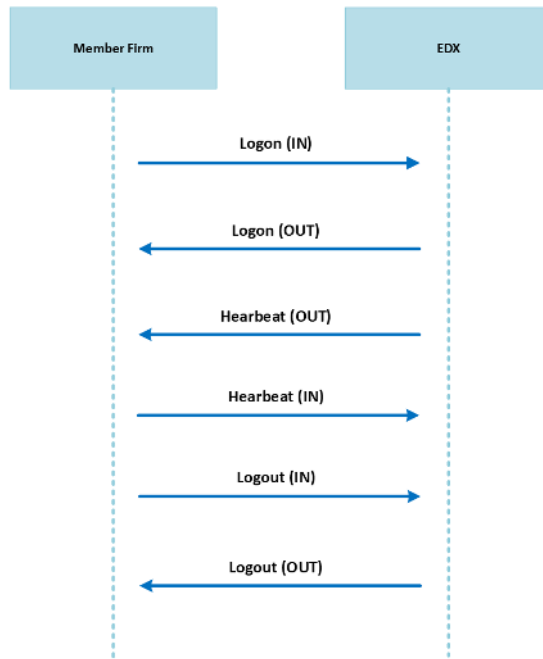

### Logon (IN)

Tag	Field Name	Req'd	Values/Comments
	Standard Header	Y	MsgType 35=A
98	EncryptMethod	Y	Must be '0'
108	HeartBtInt	Y	Heartbeat interval, in seconds. An interval of 0 indicates there are no heartbeats. The maximum supported interval is 90 seconds.
141	ResetSeqNumFlag	N	YES_RESET_SEQUENCE_NUMBERS [Y] NO [N]

553	Username	Y	Username/user ID
554	Password	Y	Password/passphrase
1137	DefaultAppVerID	Y	Must be '9'
Standard Footer		Y	

### Logon (OUT)

Tag	Field Name	Req'd	Values/Comments
Standard Header		Y	MsgType 35=A
98	EncryptMethod	Y	Must be '0'
108	HeartBtInt	Y	Heartbeat interval, in seconds. An interval of 0 indicates there are no heartbeats. The maximum supported interval is 90 seconds.
141	MsgSeqNumFlag	Y	YES_RESET_SEQUENCE_NUMBERS [Y] NO [N]
1147	DefaultAppVerID	Y	Must be '9'.
Standard Footer		Y	

### Sample Messages:

#### Logon (IN)

[BeginString]	8	=	FIXT.1.1
[BodyLength]	9	=	109
[MsgType]	35	=	A
[MsgSeqNum]	34	=	1
[SendingTime]	52	=	20240716-22:08:12.000
[SenderCompID]	49	=	USERNAME
[TargetCompID]	56	=	EDXM
[EncryptMethod]	98	=	0
[HeartBtInt]	108	=	20
[ResetSeqNumFlag]	141	=	Y
[Username]	553	=	USERNAME
[Password]	554	=	PASSWORD
[DefaultAppVerID]	1137	=	9
[Checksum]	10	=	074

## Logon (OUT)

[BeginString]	8	=	FIXT.1.1
[BodyLength]	9	=	094
[MsgType]	35	=	A
[SenderCompID]	49	=	EDXM
[TargetCompID]	56	=	USERNAME
[MsgseqNum]	34	=	2
[SendingTime]	52	=	20240716-22:08:08.655
[EncryptMethod]	98	=	0
[HeartBtInt]	108	=	20
[ResetSeqNumFlag]	141	=	Y
[DefaultApplVerID]	1137	=	9
[Checksum]	10	=	159

## Logout (IN)

Tag	Field Name	Req'd	Values/Comments
Standard Header		Y	MsgType 35=5
58	Text	N	Client provided text. Unused.
Standard Footer		Y	

## Logout (OUT)

Tag	Field Name	Req'd	Values/Comments
Standard Header		Y	MsgType 35=5
58	Text	N	Describes the reason for logout.
Standard Footer		Y	

## Sample Messages:

### Logout (IN)

[BeginString]	8	=	FIXT.1.1
[BodyLength]	9	=	55
[MsgType]	35	=	5
[MsgseqNum]	34	=	3
[SendingTime]	52	=	20240716-22:27:28.000
[SenderCompID]	49	=	USERNAME
[TargetCompID]	56	=	EDXM
[Checksum]	10	=	149

### Logout (OUT)

[BeginString]	8	=	FIXT.1.1
[BodyLength]	9	=	55
[MsgType]	35	=	5
[MsgseqNum]	34	=	4
[SenderCompID]	49	=	EDXM
[TargetCompID]	56	=	USERNAME
[SendingTime]	52	=	20240716-22:27:23.907
[Checksum]	10	=	160

### TestRequest Interaction Model:

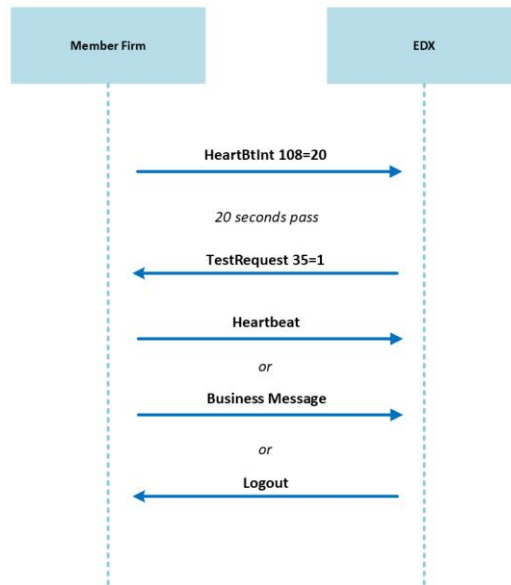

### TestRequest (OUT)

Tag	Field Name	Req'd	Values/Comments
	Standard Header	Y	MsgType 35=1
112	TestReqID	Y	Identifier included in Test Request message to be returned in resulting Heartbeat.
	Standard Footer	Y	

## Sample Messages:

### TestRequest (OUT)

[BeginString]	8	=	FIXT.1.1
[BodyLength]	9	=	63
[MsgType]	35	=	1
[MsgseqNum]	34	=	5
[SenderCompID]	49	=	EDXM
[TargetCompID]	56	=	USERNAME
[SendingTime]	52	=	20240727-01:15:22.000
[TestReqID]	112	=	23412
[Checksum]	10	=	243

### Heartbeat (IN)

[BeginString]	8	=	FIXT.1.1
[BodyLength]	9	=	55
[MsgType]	35	=	1
[MsgseqNum]	34	=	6
[SendingTime]	52	=	20240727-01:15:22.000
[SenderCompID]	49	=	USERNAME
[TargetCompID]	56	=	EDXM
[TestReqID]	112	=	23412
[Checksum]	10	=	251

### ResendRequest Interaction Model:

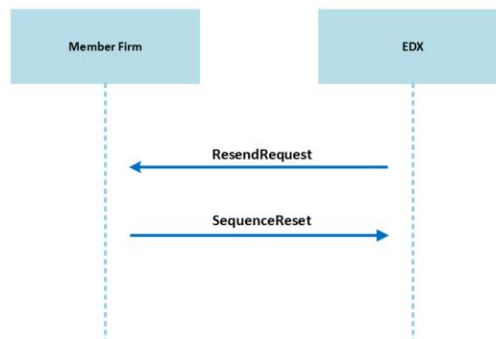

### ResendRequest (OUT)

Tag	Field Name	Req'd	Values/Comments
	Standard Header	Y	MsgType 35=2

7	BeginSeqNo	Y	First message sequence number in range to be resent.
16	EndSeqNo	Y	Last message sequence number in range to be resent. '0' represents infinity.
Standard Footer		Y	

### SequenceReset (IN)

Tag	Field Name	Req'd	Values/Comments
Standard Header		Y	MsgType 35=4
123	GapFillFlag	Y	Indicates that the Sequence Reset message is replacing the missing messages, which will not be resent. GAP_FILL_MESSAGE_MSG_SEQ_NUM_FIELD_VALID [Y]
36	NewSeqNo	Y	New sequence number.
Standard Footer		Y	

### Reject (OUT)

Tag	Field Name	Req'd	Values/Comments
Standard Header		Y	MsgType 35=3
45	RefSeqNum	Y	Reference message sequence number.
371	RefTagID	Y	The tag number of the field being referenced in the reject.
372	RegMsgType	Y	The Message Type of the FIX message being referenced.
373	SessionRejectReason	Y	Describes the reason for rejection. VALUE_IS_INCORRECT [5]
58	Text	Y	Describes the rejection reason.
Standard Footer		Y	

### Sample Messages:

#### ResendRequest (OUT)

[BeginString]	8	=	FIXT.1.1
[BodyLength]	9	=	64
[MsgType]	35	=	2
[SenderCompID]	49	=	EDXM
[TargetCompID]	56	=	USERNAME
[MsgseqNum]	34	=	7
[SendingTime]	52	=	20240727-00:06:06.000
[BeginSeqNo]	7	=	234



[EndSeqNo]	16	=	239
[Checksum]	10	=	014

### SequenceReset (IN)

[BeginString]	8	=	FIXT.1.1
[BodyLength]	9	=	71
[MsgType]	35	=	4
[MsgseqNum]	34	=	8
[SendingTime]	52	=	20240727-00:05:38.802
[SenderCompID]	49	=	USERNAME
[TargetCompID]	56	=	EDXM
[GapFillFlag]	123	=	Y
[NewSeqNo]	36	=	239
[Checksum]	10	=	149

### Reject (OUT)

[BeginString]	8	=	FIXT.1.1
[BodyLength]	9	=	129
[MsgType]	35	=	3
[SenderCompID]	49	=	EDXM
[TargetCompID]	56	=	USERNAME
[MsgseqNum]	34	=	9
[SendingTime]	52	=	20240727-00:06:06.917
[RefSeqNum]	45	=	143
[RefTagID]	371	=	16
[RefMsgType]	372	=	2
[SessionRejectReason]	373	=	5
[Text]	58	=	Value is incorrect (out of range) for this tag
[Checksum]	10	=	019

## Application Messages

### NewOrderSingle Interaction Model:

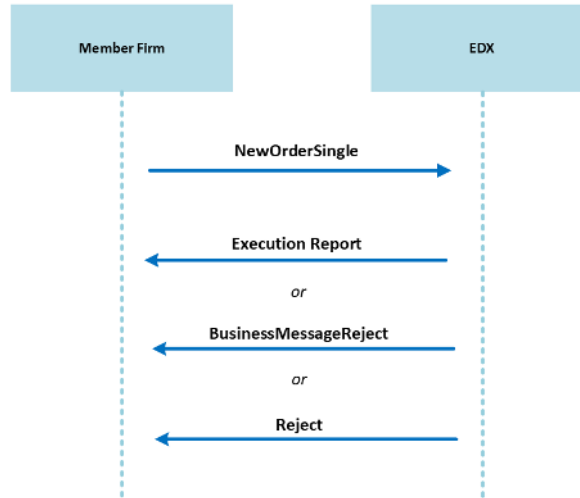

### NewOrderSingle (IN)

Tag	Field Name	Req'd	Values/Comments
Standard Header		Y	MsgType 35=D
11	ClOrdID	Y	Client Identifier for the Order.
583	ClOrdLinkID	N	Client provided metadata for the order that is echoed on Execution Reports. No behavior currently associated with this tag.
18	ExecInst	N	Additional controls around the execution of an order. Currently supported options: 6 [PARTICIPATE_DONT_INITIATE] – Indicates that this is a Post Only Limit Order.
9416	ExtendedExecInst	N	Designates that an order is a Retail order or a Retail Liquidity Providing order. R [DESIGNATED_RETAIL] – Indicates that this is a Retail Taker order. T [RETAIL_LIQUIDITY_PROVIDER] – Indicates that this is a Retail Maker order.
55	Symbol	Y	The Instrument for the Order. Example: BTC/USD ETH/USD LTC/USD

54	Side	Y	Order Side: BUY [1] – This is a buy order. SELL [2] – This is a sell order.
60	TransactTime	Y	UTC timestamp. Client provided timestamp for the message.
38	OrderQty	Y	Quantity of the order.
40	OrdType	Y	Describes the type of Order being placed: 2 [LIMIT]
44	Price	Y	The Price of the Traded Instrument. Do not include any commas.
59	TimeInForce	Y	When the order should expire: GTC [1] IOC [3] FOK [3] GTD [4] GTT [A]
126	ExpireTime	N	UTC timestamp. Expiry Time for a GTD Limit Order.
58	Text	N	Client provided text. Unused.
21001	SelfMatchPrevention	N	Defines what action to take if an order self matches: CANCEL_NEWEST [0] – Cancels the incoming aggressing order leading to the self-match. CANCEL_OLDEST [1] – Cancels the existing passive order on the book. CANCEL_BOTH [3] – Cancels both the newly placed aggressive order and the passive order on the book that it would have self-matched.
528	OrderCapacity	Y	Designates the capacity of the firm placing the order: AGENCY [A] PRINCIPAL [P] RISKLESS PRINCIPAL [R]
582	CustOrderCapacity	Y	Capacity of customer placing the order: MEMBER_TRADING_FOR_THEIR_OWN_ACCOUNT [1] RETAIL_CUSTOMER [5]
Standard Footer		Y	

### ExecutionReport (OUT)

Tag	Field Name	Req'd	Values/Comments
-----	------------	-------	-----------------

Standard Header		Y	MsgType 35=8
37	Order ID	Y	Exchange provided OrderID.
11	ClOrdID	Y	Client Identifier for the Order.
583	ClOrdLinkID	N	Client provided metadata for the order that is echoed on execution reports.
17	Exec ID	Y	Unique identifier of execution message as assigned by the exchange.
150	ExecType	Y	Specified the Type of the Execution Report: NEW [0] TRADE Partial fill or fill [F] EXPIRED [C] REJECTED [8]
39	OrdStatus	Y	Indicates the status of an order: NEW [0] PARTIALLY_FILLED [1] FILLED [2] EXPIRED [C] REJECTED [8]
103	OrdRejReason	N	Identifies the reason a new order was rejected by the system. EDX supports the following values: 0 [BROKER_EXCHANGE_OPTION] 1 [UNKNOWN_SYMBOL] 5 [UNKNOWN_ORDER] 6 [DUPLICATE_ORDER] 11 [UNSUPPORTED_ORDER_CHARACTERISTIC] 13 [INCORRECT_QUANTITY] 16 [PRICE_EXCEEDS_CURRENT_PRICE_BAND] 99 [OTHER]  EDX exclusive values: 100 [ORDER_BOOK_IN_SUSPENDED_STATE] 101 [ORDER_BOOK_IN_HALT_STATE] 102 [ORDER_BOOK_IN_EXPIRED_STATE] 103 [ORDER_BOOK_IN_LISTED_STATE] 104 [ORDER_BOOK_IN_POST_ONLY_STATE] 105 [ORDER_BREACHES_BASE_POSITION_LIMIT] 106 [ORDER_BREACHES_QUOTE_POSITION_LIMIT] 200 [ACCESS_TO_DESIGNATED_RETAIL_DENIED]

1	Account	Y	Account mnemonic.
55	Symbol	Y	The instrument for the Order. Example: BTC/USD ETH/USD LTC/USD
54	Side	Y	Order Side: BUY [1] – This is a buy order. SELL [2] – This is a sell order.
38	OrderQty	Y	Quantity of the Order.
40	OrdType	Y	Describes the type of Order being placed: LIMIT [2]
44	Price	Y	The Price of the Traded Instrument.
15	Currency	N	Identifies currency used for price or quantity fields. Example: BTC ETH LTC
59	TimeInForce	Y	When the order should expire: GOOD_TILL_CANCEL [1] IMMEDIATE_OR_CANCEL [3] FILL_OR_KILL [4] GOOD_TILL_DATE [6] GOOD_FOR_TIME [A]
126	ExpireTime	N	UTC timestamp/ Expiry Time for a GTD Limit Order.
18	ExecInst	N	Additional controls around the execution of an order. Currently supported options: PARTICIPATE_DONT_INITIATE [6] – Indicates that this is a Post Only Limit Order.
9416	ExtendedExecInst	N	Designates that an order is a Retail order or a Retail Liquidity Providing order. DESIGNATED_RETAIL [R] – Indicates that this is a Retail Taker order. [RETAIL_LIQUIDITY_PROVIDER [T] – Indicates that this is a Retail Maker order.
32	LastQty	N	Quantity bought/sold on this (last) fill.
31	Last Px	N	Price of this (last) fill.
151	LeavesQty	Y	Order Quantity available for further execution.
14	CumQty	Y	Quantity Executed in the current Order Chain.
6	AvgPx	Y	Always 0.

75	TradeDate	N	Indicates date of trade referenced in this message.
60	Transact Time	Y	Client provided timestamp for the message.
120	SettlCurrency	N	Currency code of settlement denomination.
58	Text	N	Describes rejection reason.
851	LastLiquidityInd	N	Indicates the liquidity code for this execution: 1 [ADDED_LIQUIDITY] - The order added displayed liquidity to the Exchange book. 2 [REMOVED_LIQUIDITY] - The order removed liquidity from the Exchange book. 70 [RETAIL_LIQUIDITY_ADDED] - The order available for retail access only added liquidity to the Exchange book. 71 [RETAIL_LIQUIDITY_REMOVED] - The order available for retail access only removed liquidity from the Exchange book. 170 [DESIGNATED_RETAIL_ADDED] - The designated retail-only order added liquidity to the Exchange book. 171 [DESIGNATED_RETAIL_REMOVED] - The designated retail only order removed liquidity from the Exchange book.
880	TrdMatchID	N	Identifier assigned to the Trade by the matching system.
528	OrderCapacity	Y	Designates the capacity of the firm placing the order: AGENCY [A] PRINCIPAL [P] RISKLESS_PRINCIPAL [R]
582	CustOrderCapacity	Y	Capacity of customer placing the order: MEMBER_TRADING_FOR_THEIR_OWN_ACCOUNT [1] RETAIL_CUSTOMER [5]
> 136	NoMiscFees	N	Number of repeating groups of miscellaneous fees
> 891	MiscFeeBasis	N	Defines the unit for miscellaneous fee: Always ABSOLUTE [0]
> 137	MiscFeeAmt	N	Miscellaneous fee value
> 138	MiscFeeCurr	N	Currency of miscellaneous fee. Will match the quote asset associated with the traded instrument.
> 139	MiscFeeType	N	Indicates type of miscellaneous fee. Valid values for EDX: EXCHANGE FEES [4] OTHER [7] REBATE [33]

			Other represents estimated fees for new and replaced order status
Standard Footer		Y	

### BusinessMessageReject (OUT)

Tag	Field Name	Req'd	Values/Comments
Standard Header		Y	MsgType 35=j
372	RefMsgType	Y	The Message Type of the FIX message being referenced.
380	BusinessRejectReason	Y	Code to identify reason for a Business Message Reject message.
58	Text	Y	Describes reason for rejection.
Standard Footer		Y	

### Reject (OUT)

Tag	Field Name	Req'd	Values/Comments
Standard Header		Y	MsgType 35=3
45	RefSeqNum	Y	Reference message sequence number.
371	RefTagID	Y	The tag number of the field being referenced in the reject.
372	RegMsgType	Y	The Message Type of the FIX message being referenced.
373	SessionRejectReason	Y	Describes the reason for rejection. REQUIRED_TAG_MISSING [1] VALUE_IS_INCORRECT [5]
58	Text	Y	Describes the rejection reason.
Standard Footer		Y	

### Sample Messages:

#### NewSingleOrder (IN)

[BeginString]	8	=	FIXT.1.1
[BodyLength]	9	=	140
[MsgType]	35	=	D
[MsgSeqNum]	34	=	10
[SendingTime]	52	=	20240715-00:42:43.652
[SenderCompID]	49	=	USERNAME
[TargetCompID]	56	=	EDXM
[ClOrdID]	11	=	100830204

[Side]	54	=	1
[TransactTime]	60	=	20240715-00:42:44.000
[OrdType]	40	=	2
[Price]	44	=	57000
[TimeInForce]	59	=	1
[OrderCapacity]	528	=	P
[CustOrderCapacity]	582	=	1
[Symbol]	55	=	BTC/USD
[OrderQty]	38	=	3.4928
[Checksum]	10	=	198

### ExecutionReport NEW (OUT)

[BeginString]	8	=	FIXT.1.1
[BodyLength]	9	=	140
[MsgType]	35	=	8
[SenderCompID]	49	=	EDXM
[TargetCompID]	56	=	USERNAME
[MsgseqNum]	34	=	11
[SendingTime]	52	=	20240714-21:59:12.714
[OrderID]	37	=	3247689654165569536
[ClOrdID]	11	=	100830205
[ExecID]	17	=	3247689654165569537
[ExecType]	150	=	0
[OrdStatus]	39	=	0
[Account]	1	=	USERNAME
[Symbol]	55	=	BTC/USD
[Side]	54	=	1
[OrderQty]	38	=	3.4928
[OrdType]	40	=	2
[Price]	44	=	57000
[TimeInForce]	59	=	1
[NoMiscFees]	13	=	1
[MiscFeeAmt]	137	=	9.8725
[MiscFeeCurr]	138	=	USD
[MiscFeeType]	139	=	7
[MiscFeeBasis]	891	=	0
[Checksum]	10	=	089



### ExecutionReport TRADE (OUT)

[BeginString]	8	=	FIXT.1.1
[BodyLength]	9	=	306
[MsgType]	35	=	8
[SenderCompID]	49	=	EDXM
[TargetCompID]	56	=	USERNAME
[MsgseqNum]	34	=	12
[SendingTime]	52	=	20240717-00:10:01.495
[OrderID]	37	=	3248447350061924352
[ClOrdID]	11	=	200830207
[ExecID]	17	=	3248447350061924354
[ExecType]	150	=	F
[OrdStatus]	39	=	2
[Account]	1	=	USERNAME
[Symbol]	55	=	BTC/USD
[Side]	54	=	1
[OrderQty]	38	=	3.341
[OrdType]	40	=	2
[Price]	44	=	65350
[Currency]	15	=	BTC
[TimeInForce]	59	=	1
[LastQty]	32	=	1.423
[LastPrice]	31	=	65350
[NoMiscFees]	136	=	1
[MiscFeeAmt]	137	=	9.8725
[MiscFeeCurr]	138	=	USD
[MiscFeeType]	139	=	4
[MiscFeeBasis]	891	=	0
[LastLiquidityInd]	851	=	2
[TrdMatchID]	880	=	32484474501619224351
[Checksum]	10	=	209

### ExecutionReport EXPIRED (OUT)

[BeginString]	8	=	FIXT.1.1
[BodyLength]	9	=	248
[MsgType]	35	=	8
[SenderCompID]	49	=	EDXM
[TargetCompID]	56	=	USERNAME
[MsgseqNum]	34	=	13
[SendingTime]	52	=	20240717-00:37:27.277

[OrderID]	37	=	3247482960093485773
[ClOrdID]	11	=	13442545xa2344gv
[OrigClOrdID]	41	=	13442545xa2344gv
[ExecID]	17	=	8450234902043591853
[ExecType]	150	=	C
[OrdStatus]	39	=	C
[Account]	1	=	USERNAME
[Symbol]	55	=	BTC/USD
[Side]	54	=	1
[OrderQty]	38	=	1.214
[OrdType]	40	=	2
[Price]	44	=	54523
[TimeInForce]	59	=	6
[ExpireTime]	126	=	20240717-00:37:20.000
[LeavesQty]	151	=	0
[CumQty]	14	=	0
[AvgPx]	6	=	0
[TransactTime]	60	=	20240717-00:37:27:268983611
[ChecSum]	10	=	205

**ExecutionReport REJECTED (OUT)**

[BeginString]	8	=	FIXT.1.1
[BodyLength]	9	=	223
[MsgType]	35	=	8
[SenderCompID]	49	=	EDXM
[TargetCompID]	56	=	USERNAME
[MsgseqNum]	34	=	14
[SendingTime]	52	=	20240715-00:43:30.139
[OrderID]	37	=	NONE
[ClOrdID]	11	=	200830206
[ExecID]	17	=	3246631999169122304
[ExecType]	150	=	8
[OrderStatus]	39	=	8
[OrdRejReason]	103	=	105
[Account]	1	=	USERNAME
[Symbol]	55	=	BTC/USD
[Side]	54	=	1
[OrdType]	40	=	2
[LeavesQty]	151	=	0
[CumQty]	14	=	0

[AvgPx]	6	=	0
[TransactTime]	60	=	20240715-00:43:30.126696960
[Text]	58	=	ORDER_BREACHES_BASE_POSITION_LIMIT
[Checksum]	10	=	234

### BusinessMessageReject (OUT)

[BeginString]	8	=	FIXT.1.1
[BodyLength]	9	=	89
[MsgType]	35	=	J
[SenderCompID]	49	=	EDXM
[TargetCompID]	56	=	USERNAME
[MsgseqNum]	34	=	15
[SendingTime]	52	=	20240804-20:16:24.485
[RefMsgType]	372	=	D
[BusinessRejectReason]	380	=	3
[Text]	58	=	UNHANDLED MESSAGE
[Checksum]	10	=	156

### Reject (OUT)

[BeginString]	8	=	FIXT.1.1
[BodyLength]	9	=	102
[MsgType]	35	=	3
[SenderCompID]	49	=	EDXM
[TargetCompID]	56	=	USERNAME
[MsgseqNum]	34	=	16
[SendingTime]	52	=	20240804-20:16:41.756
[RefSeqNum]	45	=	15
[RefTagID]	371	=	59
[RefMsgType]	372	=	D
[SessionRejectReason]	373	=	5
[Text]	58	=	INVALID TAG VALUE
[Checksum]	10	=	209

### OrderCancelRequest Interaction Model:

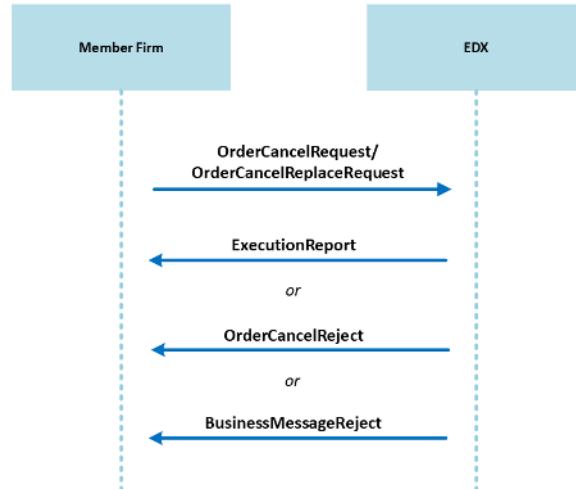

### OrderCancelRequest (IN)

Tag	Field Name	Req'd	Values/Comments
Standard Header		Y	MsgType 35=F
41	OrigClOrdID	Y	Client Identifier for the Order to be cancelled.
37	OrderID	N	Exchange provided OrderID. Currently unused.
11	ClOrdID	Y	Client Identifier for the Order.
55	Symbol	Y	The Instrument for the Order.
54	Side	Y	Order Side: BUY [1] - This is a buy order. SELL [2] - This is a sell order.
60	TransactTime	Y	Client provided timestamp for the message.
58	Text	N	Client provided text. Unused.
Standard Footer		Y	

### OrderCancelReplaceRequest (IN)

Tag	Field Name	Req'd	Comments/Values
Standard Header		Y	MsgType 35=G
37	OrderID	N	Exchange provided OrderID.
41	OrigClOrdID	Y	Client Identifier for the Order to be cancelled.
11	ClOrdID	Y	Client Identifier for the Order.
583	ClOrdLinkID	N	Client provided metadata for the order that is echoed on Execution Reports. No behavior currently associated with this tag.

18	ExecInst	N	Additional controls around the execution of an order. Currently supported options: PARTICIPATE_DONT_INITIATE [6] – Indicates that this is a Post Only Limit Order.
55	Symbol	Y	The Instrument for the Order.
54	Side	Y	Order Side: BUY [1] - This is a buy order. SELL [2] - This is a sell order.
60	TransactTime	Y	Client provided timestamp for the message. No behavior currently associated with this tag.
38	OrderQty	Y	Quantity of the Order.
40	OrdType	Y	Describes the type of Order being placed: LIMIT [2]
44	Price	Y	New Price of the Traded Instrument.
59	TimeInForce	Y	When the order should expire: 1 [GTC] 3 [IOC] 4 [FOK] 6 [GTD] A [GTD]
126	ExpireTime	N	UTC timestamp. Expiry Time for a GTD Limit Order.
58	Text	N	Client provided text. Unused.
21001	SelfMatchPrevention	N	Defines what action to take if an order self matches: CANCEL_NEWEST [0] – Cancels the existing passive order on the book. CANCEL_OLDEST [1] – Cancels the existing passive order on the book. CANCEL_BOTH [3] – Cancels both the newly placed aggressive order and the passive order on the book that it would have self-matched.
Standard Footer		Y	

### ExecutionReport (OUT)

Tag	Field Name	Req'd	Values/Comments
Standard Header		Y	MsgType 35=8
37	Order ID	Y	Exchange provided OrderID.
11	ClOrdID	Y	Client Identifier for the Order.

41	OrigClOrdID	Y	Client Identifier for the Order to be cancelled.
583	ClOrdLinkID	N	Client provided metadata for the order that is echoed on execution reports.
17	Exec ID	Y	Unique identifier of execution message as assigned by the exchange.
150	ExecType	Y	Specified the Type of the Execution Report: CANCELED [4] REPLACE [5]
39	OrdStatus	Y	Indicates the status of an order: NEW [0] CANCELED [4]
1	Account	Y	Account mnemonic
55	Symbol	Y	The instrument for the Order. Example: BTC/USD ETH/USD LTC/USD
54	Side	Y	Order Side: BUY [1] - This is a buy order. SELL [2] - This is a sell order.
38	OrderQty	Y	Quantity of the Order.
40	OrderType	Y	Describes the type of Order being placed: LIMIT [2]
44	Price	Y	The Price of the Traded Instrument.
59	TimeInForce	Y	When the order should expire: 1 [GTC] 3 [IOC] 4 [FOK] 6 [GTD] A [GTD]
126	ExpireTime	N	UTC timestamp/ Expiry Time for a GTD Limit Order.
18	ExecInst	N	Additional controls around the execution of an order. Currently supported options: 6 [PARTICIPATE_DONT_INITATE] – Indicates that this is a Post Only Limit Order.
9416	ExtendedExecInst	N	Designates that an order is a Retail order or a Retail Liquidity Providing order. R [DESIGNATED_RETAIL] – Indicates that this is a Retail Taker order.

			T [RETAIL_LIQUIDITY_PROVIDER] – Indicates that this is a Retail Maker order.
151	LeavesQty	Y	Order Quantity available for further execution.
14	CumQty	Y	Quantity Executed in the current Order Chain.
6	AvgPx	Y	Always '0'
60	Transact Time	Y	Client provided timestamp for the message.
58	Text	N	Free format text.
> 136	NoMiscFees	N	Number of repeating groups of miscellaneous fees
> 891	MiscFeeBasis	N	Defines the unit for miscellaneous fee: Always ABSOLUTE [0]
> 137	MiscFeeAmt	N	Miscellaneous fee value
> 138	MiscFeeCurr	N	Currency of miscellaneous fee. Will match the quote asset associated with the traded instrument.
> 139	MiscFeeType	N	Indicates type of miscellaneous fee. Valid values for EDX: EXCHANGE FEES [4] OTHER [7] REBATE [33]  Other represents estimated fees for new and replaced order status
Standard Footer		Y	

### OrderCancelReject (OUT)

Tag	Field Name	Req'd	Values/Comments
Standard Header		Y	MsgType 35=9
37	OrderID	Y	Exchange provided OrderID.
11	ClOrdID	Y	Client Identifier for the Order.
583	ClOrdLinkID	N	Permits order originators to tie together groups of orders in which trades resulting from orders are associated for a specific purpose, for example the calculation of average execution price for a customer.
41	OrigClOrdID	Y	Client Identifier for the Order to be cancelled.
39	OrdStatus	Y	Indicates the status of an order: REJECTED [8]
60	TransactTime	Y	Client provided timestamp for the message.
434	CxlRejResponseTo	Y	Indicates the message type the Reject is in response to.

102	CxlRejReason	Y	The code which identifies the reason for the cancel reject. EDX's system supports the following values: UNKNOWN_ORDER [1] PRICE_EXCEEDS_CURRENT_PRICE_BAND [8] OTHER [99]  EDX exclusive values: ORDER_BREACHES_BASE_POSITION_LIMIT [16] ORDER_BREACHES_QUOTE_POSITION_LIMIT [17] ORDER_BOOK_IN_SUSPENDED_STATE [100] ORDER_BOOK_IN_HALT_STATE [101] ORDER_BOOK_IN_EXPIRED_STATE [102] ORDER_BOOK_IN_LISTED_STATE [103] ORDER_BOOK_IN_POST_ONLY_STATE [104]
58	Text	Y	Describes reason for rejection.
Standard Footer		Y	

### BusinessMessageReject (OUT)

Tag	Field Name	Req'd	Values/Comments
Standard Header		Y	MsgType=35=j
372	RefMsgType	Y	The Message Type of the FIX message being referenced.
380	BusinessRejectReason	Y	Code to identify reason for a Business Message Reject message.
58	Text	Y	Describes reason for rejection.
Standard Footer		Y	

### Sample Messages:

#### OrderCancelRequest (IN)

[BeginString]	8	=	FIXT.1.1
[BodyLength]	9	=	106
[MsgType]	35	=	F
[MsgSeqNum]	34	=	17
[SendingTime]	52	=	20240716-23:22:56.000
[SenderCompID]	49	=	USERNAME
[TargetCompID]	56	=	EDXM
[OrigClOrdID]	41	=	32443212305



[ClOrdID]	11	=	23564832459
[Side]	54	=	1
[TransactTime]	60	=	20240716-23:22:53.000
[Symbol]	55	=	BTC/USD
[Checksum]	10	=	185

### OrderCancelReplaceRequest (IN)

[BeginString]	8	=	FIXT.1.1
[BodyLength]	9	=	132
[MsgType]	35	=	G
[MsgSeqNum]	34	=	18
[SendingTime]	52	=	20240720-01:14:02.000
[SenderCompID]	49	=	USERNAME
[TargetCompID]	56	=	EDXM
[OrigClOrdID]	41	=	31245JKf92
[ClOrdID]	11	=	43324FsJ31
[Side]	54	=	1
[TransactTime]	60	=	20240720-01:13:52.000
[OrdType]	40	=	2
[Price]	44	=	53000
[TimeInForce]	59	=	1
[Symbol]	55	=	BTC/USD
[OrderQty]	38	=	2.422
[Checksum]	10	=	037

### ExecutionReport CANCELLED (OUT)

[BeginString]	8	=	FIXT.1.1
[BodyLength]	9	=	236
[MsgType]	35	=	8
[SenderCompID]	49	=	EDXM
[TargetCompID]	56	=	USERNAME
[MsgseqNum]	34	=	19
[SendingTime]	52	=	20240713-22:50.01.068
[OrderID]	37	=	3247449971403947362
[ClOrdID]	11	=	2452547xbha9834HG83
[OrigClOrdID]	41	=	1343143fsdh938VK92
[ExecID]	17	=	8359285506034856357
[ExecType]	150	=	4

[OrderStatus]	39	=	4
[Account]	1	=	USERNAME
[Symbol]	55	=	BTC/USD
[Side]	54	=	1
[OrderQty]	38	=	1.1
[OrdType]	40	=	2
[Price]	44	=	55847
[TimeInForce]	59	=	1
[LeavesQty]	151	=	0
[CumQty]	14	=	0
[AvgPx]	6	=	0
[TransactTime]	60	=	20240713-22:50:01.064791452
[Text]	58	=	USER_INITIATED
[Checksum]	10	=	170

### ExecutionReport REPLACE (OUT)

[BeginString]	8	=	FIXT.1.1
[BodyLength]	9	=	221
[MsgType]	35	=	8
[SenderCompID]	49	=	EDXM
[TargetCompID]	56	=	USERNAME
[MsgseqNum]	34	=	20
[SendingTime]	52	=	20240720-01:13:57.890
[OrderID]	37	=	3249559602857362573
[ClOrdID]	11	=	24524132494
[OrigClOrdID]	41	=	36685465446
[ExecID]	17	=	3459330504892394859
[ExecType]	150	=	5
[OrdStatus]	39	=	0
[Account]	1	=	USERNAME
[Symbol]	55	=	BTC/USD
[Side]	54	=	1
[OrderQty]	38	=	5.43
[OrdType]	40	=	2
[Price]	44	=	53000
[TimeInForce]	59	=	1
[NoMiscFees]	136	=	1
[MiscFeeAmt]	137	=	9.8725
[MiscFeeCurr]	138	=	USD
[MiscFeeType]	139	=	7

[MiscFeeBasis]	891	=	0
----------------	-----	---	---

### ExecutionReport ADMINISTRATIVE CANCEL (OUT)

[BeginString]	8	=	FIXT.1.1
[BodyLength]	9	=	262
[MsgType]	35	=	8
[SenderCompID]	49	=	EDXM
[TargetCompID]	56	=	USERNAME
[MsgseqNum]	34	=	21
[SendingTime]	52	=	20240720-20:34:04.054
[OrderID]	37	=	4259821452982942499
[ClOrdID]	11	=	4259821452982942499
[OrigClOrdID]	41	=	2453252352
[ExecID]	17	=	3249842774981893592
[ExecType]	150	=	4
[OrdStatus]	39	=	4
[Account]	1	=	USERNAME
[Symbol]	55	=	BTC/USD
[Side]	54	=	1
[OrderQty]	38	=	2.35
[OrdType]	40	=	2
[Price]	44	=	63240
[TimeInForce]	59	=	1
[LeavesQty]	151	=	0
[CumQty]	14	=	0
[AvgPx]	6	=	0
[TransactTime]	60	=	20240720-20:34:04.048559828
[Text]	58	=	AMINISTRATIVE_CANCEL
[Checksum]	10	=	095

### OrderCancelReject (OUT)

[BeginString]	8	=	FIXT.1.1
[BodyLength]	9	=	140
[MsgType]	35	=	9
[SenderCompID]	49	=	EDXM
[TargetCompID]	56	=	USERNAME
[MsgseqNum]	34	=	22
[SendingTime]	52	=	20240714-23:04:44.793

[OrdID]	37	=	NONE
[ClOrdID]	11	=	48392004
[OrigClOrdID]	41	=	243598245
[OrdStatus]	39	=	8
[TransactTime]	60	=	20240714-23:04:44.787207021
[CxlRejResponseTo]	434	=	1
[CxlRejReason]	102	=	1
[Text]	58	=	UNKNOWN_ORDER
[Checksum]	10	=	103

**BusinessMessageReject (OUT)**

[BeginString]	8	=	FIXT.1.1
[BodyLength]	9	=	89
[MsgType]	35	=	j
[SenderCompID]	49	=	EDXM
[TargetCompID]	56	=	USERNAME
[MsgseqNum]	34	=	23
[SendingTime]	52	=	20240804-21:27:00.775
[RefMsgType]	372	=	G
[BusinessRejectReason]	380	=	3
[Text]	58	=	UNHANDLED MESSAGE
[Checksum]	10	=	152

**OrderMassStatusRequest Interaction Model:**

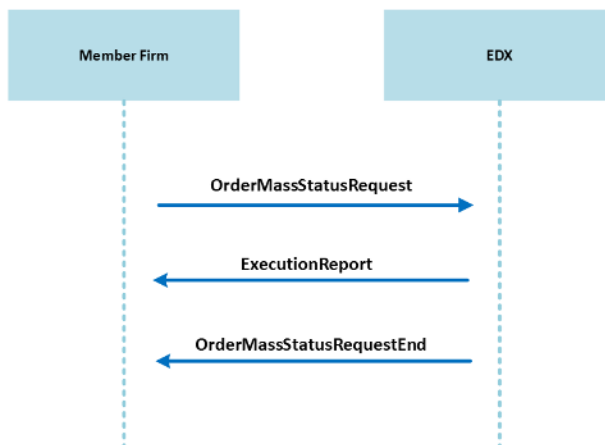

## OrderMassStatusRequest (IN)

Tag	Field Name	Req'd	Comments/Values
	Standard Header	Y	MsgType 35=AF
584	MassStatusReqID	Y	Value assigned by issuer of Mass Status Request to uniquely identify the request.
585	MassStatusReqType	Y	Must be '7'. STATUS_FOR_ALL_ORDERS [7]
	Standard Footer	Y	

## ExecutionReport (OUT)

Tag	Field Name	Req'd	Values/Comments
	Standard Header	Y	MsgType 35=8
37	Order ID	Y	Exchange provided OrderID.
11	ClOrdID	Y	Client Identifier for the Order.
583	ClOrdLinkID	N	Client provided metadata for the order that is echoed on execution reports.
17	Exec ID	Y	Unique identifier of execution message as assigned by the exchange.
150	ExecType	Y	Specified the Type of the Execution Report: ORDER_STATUS [I]
39	OrdStatus	Y	Indicates the status of an order: NEW [0] PARTIALLY_FILLED [1]
55	Symbol	Y	The instrument for the Order. Example: BTC/USD ETH/USD LTC/USD
54	Side	Y	Order Side: BUY [1] – This is a buy order. SELL [2] – This is a sell order.
38	OrderQty	Y	Quantity of the Order.
40	OrdType	Y	Describes the type of Order being placed: LIMIT [2]
44	Price	Y	The Price of the Traded Instrument.
59	TimeInForce	Y	When the order should expire: GOOD_TILL_CANCEL [1]

			IMMEDIATE_OR_CANCEL [3] FILL_OR_KILL [4] GOOD_TILL_DATE [6] GOOD_FOR_TIME [A]
126	ExpireTime	N	UTC timestamp/ Expiry Time for a GTD Limit Order.
18	ExecInst	N	Additional controls around the execution of an order. Currently supported options: PARTICIPATE_DONT_INITIATE [6] – Indicates that this is a Post Only Limit Order.
9416	ExtendedExecInst	N	Designates that an order is a Retail order or a Retail Liquidity Providing order. DESIGNATED_RETAIL [R] – Indicates that this is a Retail Taker order. [RETAIL_LIQUIDITY_PROVIDER [T] – Indicates that this is at Retail Maker order.
32	LastQty	N	Quantity bought/sold on this (last) fill.
31	Last Px	N	Price of this (last) fill.
151	LeavesQty	Y	Order Quantity available for further execution.
14	CumQty	Y	Quantity Executed in the current Order Chain.
6	AvgPx	Y	Always '0'.
75	TradeDate	N	Indicates date of trade referenced in this message.
60	Transact Time	Y	Client provided timestamp for the message.
584	MassStatusReqID	Y	Value assigned by issuer of Mass Status Request to uniquely identify the request.
> 136	NoMiscFees	N	Number of repeating groups of miscellaneous fees
> 891	MiscFeeBasis	N	Defines the unit for miscellaneous fee: Always ABSOLUTE [0]
> 137	MiscFeeAmt	N	Miscellaneous fee value
> 138	MiscFeeCurr	N	Currency of miscellaneous fee. Will match the quote asset associated with the traded instrument.
> 139	MiscFeeType	N	Indicates type of miscellaneous fee. Valid values for EDX: EXCHANGE FEES [4] OTHER [7] REBATE [33]

			Other represents estimated fees for new and replaced order status
Standard Footer		Y	

### OrderMassStatusRequestEnd (OUT)

Tag	Field Name	Req'd	Values/Comments
Standard Header		Y	MsgType 35=UMS
584	MassStatusReqID	Y	Value assigned by issuer of Mass Status Request to uniquely identify the request.
Standard Footer		Y	

### Sample Messages:

#### OrderMassStatusRequest (IN)

[BeginString]	8	=	FIXT.1.1
[BodyLength]	9	=	69
[MsgType]	35	=	AF
[MsgSeqNum]	34	=	24
[SendingTime]	52	=	20240720-18:29:45.000
[SenderCompID]	49	=	USERNAME
[TargetCompID]	56	=	EDXM
[MassStatusReqID]	584	=	4
[MassStatusReqType]	585	=	7
[Checksum]	10	=	070

#### ExecutionReport (OUT)

[BeginString]	8	=	FIXT.1.1
[BodyLength]	9	=	197
[MsgType]	35	=	8
[SenderCompID]	49	=	EDXM
[TargetCompID]	56	=	USERNAME
[MsgseqNum]	34	=	25
[SendingTime]	52	=	20240720-18:29:40.538
[OrderID]	37	=	4350920973394905095
[ClOrdID]	11	=	534ui345h435
[ExecID]	17	=	0

[ExecType]	150	=	I
[OrderStatus]	39	=	0
[Symbol]	55	=	ETH/USD
[Side]	54	=	1
[OrderQty]	38	=	34.323
[OrdType]	40	=	2
[Price]	44	=	3700
[TimeInForce]	59	=	1
[LeavesQty]	151	=	34.323
[CumQty]	14	=	0
[AvgPx]	6	=	0
[TransactTime]	60	=	20240720-18:28:31.9774533139
[MassStatusReqID]	584	=	4
[Checksum]	10	=	116

**OrderMassStatusRequestEnd (OUT)**

[BeginString]	8	=	FIXT.1.1
[BodyLength]	9	=	64
[MsgType]	35	=	UMS
[SenderCompID]	49	=	EDXM
[TargetCompID]	56	=	USERNAME
[MsgseqNum]	34	=	26
[SendingTime]	52	=	20240720-18:29:40.538
[MassStatusReqID]	584	=	4
[Checksum]	10	=	164

**OrderMassCancelRequest Interaction Model:**

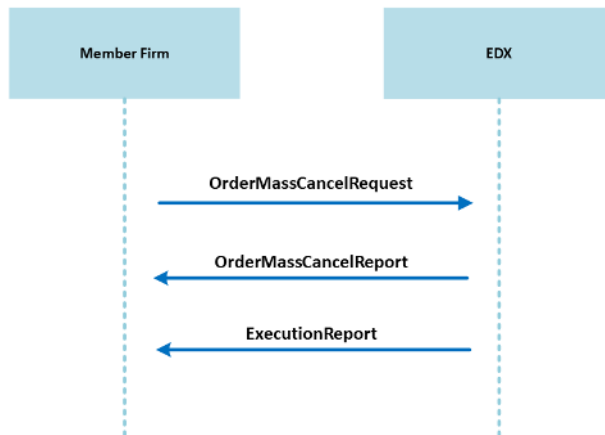



## OrderMassCancelRequest (IN)

Tag	Field Name	Req'd	Comments/Values
Standard Header		Y	MsgType 35=q
11	ClOrdID	Y	Client identifier for the order.
530	MassCancelRequestType	Y	Specifies the Type of the Mass Cancel Request: CANCEL_ORDERS_FOR_SECURITY [1] CANCEL_ALL_ORDERS [7]
55 <sup>†</sup>	Symbol	Y	The Instrument for the order. Example: BTC/USD ETH/USD LTC/USD
54	Side	N	Order Side: BUY [1] – This is a buy order. SELL [2] – This is a sell order.
60	TransactTime	Y	Client provided timestamp for the message.
58	Text	N	Client provided text. Unused.
Standard Footer		Y	

<sup>†</sup> = For OrderMassCancelRequest (IN) messages, tag 55 (Symbol) is required even if cancelling all orders. For example, if a client has 1 open order on LTC and 1 on ETH, in the OrderMassCancelRequest, the client can send either value in tag 55, and set tag 530=7, and both orders will be cancelled.

## OrderMassCancelReport (OUT)

Tag	Field Name	Req'd	Comments/Values
Standard Header		Y	MsgType 35=r
37	OrderID	Y	Exchange provided OrderID.
11	ClOrdID	Y	Client identifier for the order.
530	MassCancelRequestType	Y	Specifies the Type of the Mass Cancel Request: CANCEL_ORDERS_FOR_SECURITY [1] CANCEL_ALL_ORDERS [7]
531	MassCancelResponse	Y	Indicates the action taken by Recipient of the Order Mass Cancel request, including reject. CANCEL_REQUEST_REJECTED [0] CANCEL_ORDERS_FOR_A_SECURITY [1] CANCEL_ALL_ORDERS [7]
532	MassCancelRejectReason	N	Describes the reason Mass Order Cancel Request was rejected. INVALID_OR_UNKNOWN_SECURITY [1]

60	TransactTime	Y	UTC timestamp. Client provided timestamp for the message.
Standard Footer		Y	

### ExecutionReport (OUT)

Tag	Field Name	Req'd	Values/Comments
Standard Header		Y	MsgType 35=8
37	Order ID	Y	Exchange provided OrderID.
11	ClOrdID	Y	Client Identifier for the Order.
41	OrigClOrdID	Y	Client Identifier for the Order to be cancelled.
583	ClOrdLinkID	N	Client provided metadata for the order that is echoed on execution reports.
17	Exec ID	Y	Unique identifier of execution message as assigned by the exchange.
150	ExecType	Y	Specified the Type of the Execution Report: CANCELED [4]
39	OrdStatus	Y	Indicates the status of an order: CANCELED [4]
1	Account	Y	Account mnemonic.
55	Symbol	Y	The instrument for the Order. Example: BTC/USD ETH/USD LTC/USD
54	Side	Y	Order Side: BUY [1] - This is a buy order. SELL [2] - This is a sell order.
38	OrderQty	Y	Quantity of the Order.
40	OrderType	Y	Describes the type of Order being placed: LIMIT [2]
44	Price	Y	The Price of the Traded Instrument.
59	TimeInForce	Y	When the order should expire: 1 [GTC] 3 [IOC] 4 [FOK] 6 [GTD] A [GTD]
126	ExpireTime	N	UTC timestamp/ Expiry Time for a GTD Limit Order.

18	ExecInst	N	Additional controls around the execution of an order. Currently supported options: 6 [PARTICIPATE_DONT_INITATE] – Indicates that this is a Post Only Limit Order
9416	ExtendedExecInst	N	Designates that an order is a Retail order or a Retail Liquidity Providing order. R [DESIGNATED_RETAIL] – Indicates that this is a Retail Taker order. T [RETAIL_LIQUIDITY_PROVIDER] – Indicates that this is a Retail Maker order.
151	LeavesQty	Y	Order Quantity available for further execution.
14	CumQty	Y	Quantity Executed in the current Order Chain.
6	AvgPx	Y	Always 0.
60	Transact Time	Y	Client provided timestamp for the message.
> 136	NoMiscFees	N	Number of repeating groups of miscellaneous fees
> 891	MiscFeeBasis	N	Defines the unit for miscellaneous fee: Always ABSOLUTE [0]
> 137	MiscFeeAmt	N	Miscellaneous fee value
> 138	MiscFeeCurr	N	Currency of miscellaneous fee. Will match the quote asset associated with the traded instrument.
> 139	MiscFeeType	N	Indicates type of miscellaneous fee. Valid values for EDX: EXCHANGE FEES [4] OTHER [7] REBATE [33]  Other represents estimated fees for new and replaced order status
Standard Footer		Y	

### Sample Messages:

#### OrderMassCancelRequest (IN)

[BeginString]	8	=	FIXT.1.1
[BodyLength]	9	=	69
[MsgType]	35	=	q
[MsgSeqNum]	34	=	27

[SendingTime]	52	=	20240720-19:43:17.000
[SenderCompID]	49	=	USERNAME
[TargetCompID]	56	=	EDXM
[ClOrdID]	11	=	32432413413
[MassCancelRequestType]	530	=	7
[TransactTime]	60	=	20240720-19:43:11.000
[Symbol]	55	=	BTC/USD
[Checksum]	10	=	111

### OrderMassCancelReport (OUT)

[BeginString]	8	=	FIXT.1.1
[BodyLength]	9	=	127
[MsgType]	35	=	R
[SenderCompID]	49	=	EDXM
[TargetCompID]	56	=	USERNAME
[MsgseqNum]	34	=	28
[SendingTime]	52	=	20240720-19:43:12.203
[OrderID]	37	=	3249829853805061694
[ClOrdID]	11	=	34133413412345
[MassCancelRequestType]	530	=	7
[MassCancelResponse]	531	=	7
[TransactTime]	60	=	20240720-19:43:12.196992734
[Checksum]	10	=	220

### ExecutionReport (OUT)

[BeginString]	8	=	FIXT.1.1
[BodyLength]	9	=	233
[MsgType]	35	=	8
[SenderCompID]	49	=	EDXM
[TargetCompID]	56	=	USERNAME
[MsgseqNum]	34	=	29
[SendingTime]	52	=	20240720-19:43:12.203
[OrderID]	37	=	4359829438244485384
[ClOrdID]	11	=	325483148901234
[OrigClOrdID]	41	=	231531531441244
[ExecID]	17	=	43599832957364758432
[ExecType]	150	=	4
[OrderStatus]	39	=	4

[Account]	1	=	USERNAME
[Symbol]	55	=	ETH/USD
[Side]	54	=	2
[OrderQty]	38	=	24.663
[OrdType]	40	=	2
[Price]	44	=	3649
[TimeInForce]	59	=	1
[LeavesQty]	151	=	0
[CumQty]	14	=	0
[AvgPx]	6	=	0
[TransactTime]	60	=	20240720-19:43:12.196992734
[Text]	58	=	MASS_CANCEL
[Checksum]	10	=	221